

Primary Lockers

BISLEY

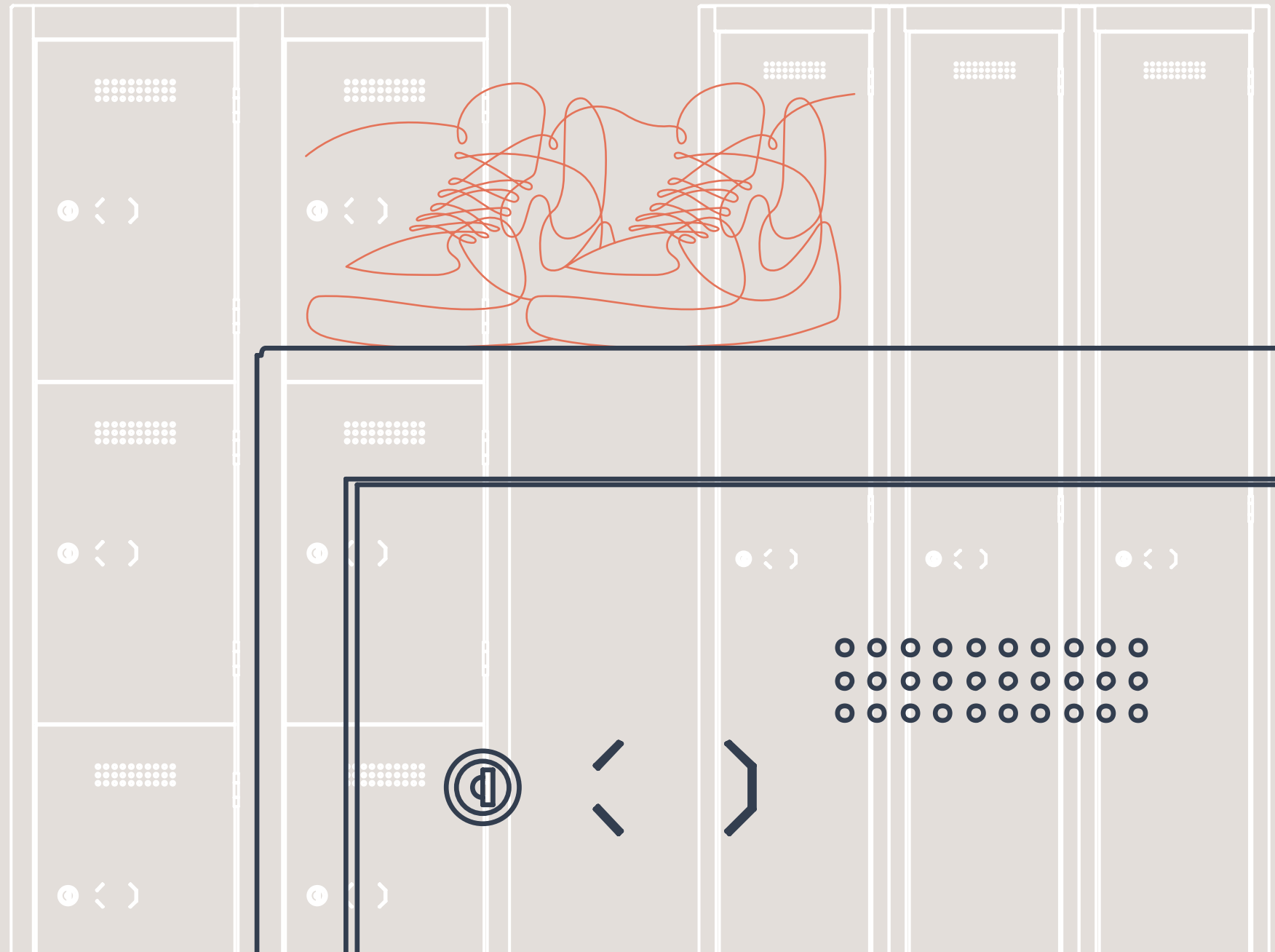

PRIMARY LOCKERS

Robust, versatile and hard-wearing - Lockers crafted for the workplace.

Primary Lockers by Bisley span a wide range of sizes and configurations, allowing you to stow your personal belongings, workwear or equipment as required. With perfect sized compartments to suit every need; whether you're storing uniform and bulky items, to separating your clothes from dirty overalls. Designed for durability, these lockers are aimed at fulfilling tough 'back of house' storage requirements, but the neat and minimalist design means they will look great in changing rooms and customer facing cloakrooms too.

This straightforward locker range is easy to specify. Featuring a smart grey carcass and a selection of door colours, there is also a range of optional upgrades including benching, feet, sloping tops and a choice of locking options.

Available in single columns or nests of up to four lockers together, Primary Lockers work around your space and capacity.

Primary Lockers: Built to last.



Everyday Lockers

3 Introduction

Everyday Lockers range overview

4 1800mm (71") high lockers

6 Lower height lockers

Workwear Lockers

9 Introduction

Workwear Lockers range overview

10 Police Lockers

10 Clean and Dirty Lockers

10 Combi Lockers

11 Two Person Lockers

11 Twin Lockers

Galvanized steel

12 Galvanized steel

Accessories

14 Locker stands and benches

15 Locker sloping tops

16 Locking solutions

Finishing touches

18 Paint finishes

Our commitment

19 Our commitment

Contact

20 Get in touch

EVERYDAY LOCKERS

Built to last

Uncomplicated and resilient, the Everyday Locker is a workplace essential. Available in a range of heights, widths, depths, and divided into one to six doors, you can choose a configuration that best suits your workforce's personal storage requirements.

Everyday Lockers are available as single columns or in nests of two, three or four. They feature a light grey carcass as standard and have a choice of door colours, with the option to upgrade to anti-microbial paint. Alternatively, if the lockers will be placed in areas susceptible to rusting, or you require an extra level of protection, Everyday Lockers can be specified in galvanized steel, with the same paint finishes available.* Plus, you can choose a specific lock option, moulded feet, or a steel stand to lift lockers off the ground and add benching or sloping tops if required.



- Ventilated doors allow air to flow through the lockers
- Discreet label holders on all doors
- Strong hinges withstand rough handling
- Add optional sloping tops, steel lockers stands or raised feet with leveling capabilities
- Choose from a selection of popular industry paints available for door fronts, or specify Biocote paint finishes to inhibit bacteria growth by 99.99%*
- Lockers can be specified in galvanized steel for added protection against corrosion and damage*
- Choose from a selection of locks to suit different industry needs

* Surcharges apply.



 All lockers are fitted with **AB locks** as standard. Take a look at alternative locking options here.

EVERYDAY LOCKERS RANGE OVERVIEW

1800mm (71") high lockers

1 door



External		Internal (Below shelf)	Internal (Above shelf)	Internal dimensions per locker compartment		Nests available
W 225mm (9")	D 450mm (17.7")	H 1319mm (51.9")	H 318mm (12.5")	W 140mm (5.5")	D 428mm (16.9")	1 2
W 300mm (11.8")	D 300mm (11.8")	H 1319mm (51.9")	H 318mm (12.5")	W 215mm (8.5")	D 278mm (11")	1 2 3 4
W 300mm (11.8")	D 380mm (15")	H 1319mm (51.9")	H 318mm (12.5")	W 215mm (8.5")	D 358mm (14.1")	1 2 3 4
W 300mm (11.8")	D 450mm (17.7")	H 1319mm (51.9")	H 318mm (12.5")	W 215mm (8.5")	D 428mm (16.9")	1 2 3 4
W 300mm (11.8")	D 600mm (23.6")	H 1319mm (51.9")	H 318mm (12.5")	W 215mm (8.5")	D 578mm (22.8")	1 2 3 4
W 380mm (15")	D 380mm (15")	H 1319mm (51.9")	H 318mm (12.5")	W 295mm (11.6")	D 358mm (14.1")	1 2 3
W 380mm (15")	D 510mm (20")	H 1319mm (51.9")	H 318mm (12.5")	W 295mm (11.6")	D 488mm (19.2")	1 2 3
W 380mm (15")	D 600mm (23.6")	H 1319mm (51.9")	H 318mm (12.5")	W 295mm (11.6")	D 578mm (22.8")	1 2 3
W 450mm (17.7")	D 450mm (17.7")	H 1319mm (51.9")	H 318mm (12.5")	W 365mm (14.4")	D 428mm (16.9")	1 2
W 450mm (17.7")	D 510mm (20")	H 1319mm (51.9")	H 318mm (12.5")	W 365mm (14.4")	D 488mm (19.2")	1 2
W 450mm (17.7")	D 600mm (23.6")	H 1319mm (51.9")	H 318mm (12.5")	W 365mm (14.4")	D 578mm (22.8")	1 2
W 600mm (23.6")	D 450mm (17.7")	H 1319mm (51.9")	H 318mm (12.5")	W 515mm (20.3")	D 428mm (16.9")	1 2

This locker includes 1 internal shelf and 1 coat hook.

2 doors

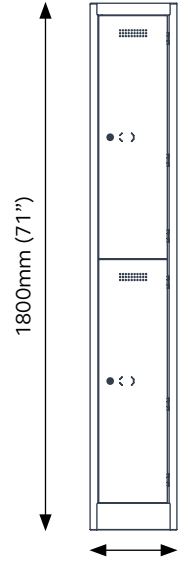

External		Internal dimensions per locker compartment			Nests available
W 225mm (9")	D 450mm (17.7")	H 805mm (31.7")	W 140mm (5.5")	D 428mm (16.9")	1 2
W 300mm (11.8")	D 300mm (11.8")	H 805mm (31.7")	W 215mm (8.5")	D 278mm (10.9")	1 2 3 4
W 300mm (11.8")	D 380mm (15")	H 805mm (31.7")	W 215mm (8.5")	D 358mm (14.1")	1 2 3 4
W 300mm (11.8")	D 450mm (17.7")	H 805mm (31.7")	W 215mm (8.5")	D 428mm (16.9")	1 2 3 4
W 300mm (11.8")	D 600mm (23.6")	H 805mm (31.7")	W 215mm (8.5")	D 578mm (22.8")	1 2 3 4
W 380mm (15")	D 380mm (15")	H 805mm (31.7")	W 295mm (11.6")	D 358mm (14.1")	1 2 3
W 380mm (15")	D 510mm (20")	H 805mm (31.7")	W 295mm (11.6")	D 488mm (19.2")	1 2 3
W 380mm (15")	D 600mm (23.6")	H 805mm (31.7")	W 295mm (11.6")	D 488mm (19.2")	1 2 3
W 450mm (17.7")	D 450mm (17.7")	H 805mm (31.7")	W 365mm (14.4")	D 428mm (16.9")	1 2
W 450mm (17.7")	D 510mm (20")	H 805mm (31.7")	W 365mm (14.4")	D 488mm (19.2")	1 2
W 450mm (17.7")	D 600mm (23.6")	H 805mm (31.7")	W 365mm (14.4")	D 578mm (22.8")	1 2
W 600mm (23.6")	D 450mm (17.7")	H 805mm (31.7")	W 515mm (20.3")	D 428mm (16.9")	1 2

This locker includes shelf positions so internal shelves can be added as optional extras.

3 doors

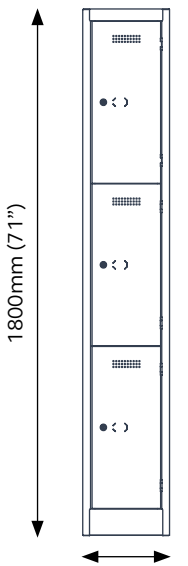

External		Internal dimensions per locker compartment			Nests available
W 225mm (9")	D 450mm (17.7")	H 527mm (20.8")	W 140mm (5.5")	D 428mm (16.9")	1 2
W 300mm (11.8")	D 300mm (11.8")	H 527mm (20.8")	W 215mm (8.5")	D 278mm (11")	1 2 3 4
W 300mm (11.8")	D 380mm (15")	H 527mm (20.8")	W 215mm (8.5")	D 358mm (14.1")	1 2 3 4
W 300mm (11.8")	D 450mm (17.7")	H 527mm (20.8")	W 215mm (8.5")	D 428mm (16.9")	1 2 3 4
W 300mm (11.8")	D 600mm (23.6")	H 527mm (20.8")	W 215mm (8.5")	D 578mm (22.8")	1 2 3 4
W 380mm (15")	D 380mm (15")	H 527mm (20.8")	W 295mm (11.6")	D 358mm (14.1")	1 2 3
W 380mm (15")	D 510mm (20")	H 527mm (20.8")	W 295mm (11.6")	D 488mm (19.2")	1 2 3
W 380mm (15")	D 600mm (23.6")	H 527mm (20.8")	W 295mm (11.6")	D 578mm (22.8")	1 2 3
W 450mm (17.7")	D 450mm (17.7")	H 527mm (20.8")	W 365mm (14.4")	D 428mm (16.9")	1 2
W 450mm (17.7")	D 510mm (20")	H 527mm (20.8")	W 365mm (14.4")	D 488mm (19.2")	1 2
W 450mm (17.7")	D 600mm (23.6")	H 527mm (20.8")	W 365mm (14.4")	D 578mm (22.8")	1 2
W 600mm (23.6")	D 450mm (17.7")	H 527mm (20.8")	W 515mm (20.3")	D 428mm (16.9")	1 2

This locker includes shelf positions so internal shelves can be added as optional extras.

4 doors

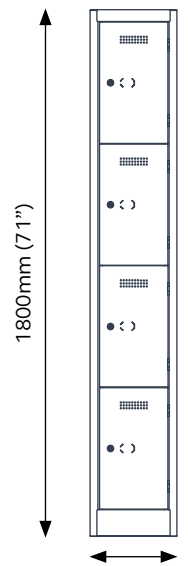

External		Internal dimensions per locker compartment			Nests available
W 225mm (9")	D 450mm (17.7")	H 388mm (15.3")	W 140mm (5.5")	D 428mm (16.9")	1 2
W 300mm (11.8")	D 300mm (11.8")	H 388mm (15.3")	W 215mm (8.5")	D 278mm (10.9")	1 2 3 4
W 300mm (11.8")	D 380mm (15")	H 388mm (15.3")	W 215mm (8.5")	D 358mm (14.1")	1 2 3 4
W 300mm (11.8")	D 450mm (17.7")	H 388mm (15.3")	W 215mm (8.5")	D 428mm (16.9")	1 2 3 4
W 300mm (11.8")	D 600mm (23.6")	H 388mm (15.3")	W 215mm (8.5")	D 578mm (22.8")	1 2 3 4
W 380mm (15")	D 380mm (15")	H 388mm (15.3")	W 295mm (11.6")	D 358mm (14.1")	1 2 3
W 380mm (15")	D 510mm (20")	H 388mm (15.3")	W 295mm (11.6")	D 488mm (19.2")	1 2 3
W 380mm (15")	D 600mm (23.6")	H 388mm (15.3")	W 295mm (11.6")	D 578mm (22.8")	1 2 3
W 450mm (17.7")	D 450mm (17.7")	H 388mm (15.3")	W 365mm (14.4")	D 428mm (16.9")	1 2
W 450mm (17.7")	D 510mm (20")	H 388mm (15.3")	W 365mm (14.4")	D 488mm (19.2")	1 2
W 450mm (17.7")	D 600mm (23.6")	H 388mm (15.3")	W 365mm (14.4")	D 578mm (22.8")	1 2
W 600mm (23.6")	D 450mm (17.7")	H 388mm (15.3")	W 515mm (20.3")	D 428mm (16.9")	1 2

This locker includes shelf positions so internal shelves can be added as optional extras.

Line drawings are for illustrative purposes only.



All lockers are fitted with **AB locks** as standard. Take a look at alternative locking options here.

EVERYDAY LOCKERS RANGE OVERVIEW

1800mm (71") high lockers

5 doors



External		Internal dimensions per locker compartment			Nests available
W 225mm (9")	D 450mm (17.7")	H 304mm (12")	W 140mm (5.5")	D 428mm (16.9")	1 2
W 300mm (11.8")	D 300mm (11.8")	H 304mm (12")	W 215mm (8.5")	D 278mm (10.9")	1 2 3 4
W 300mm (11.8")	D 380mm (15")	H 304mm (12")	W 215mm (8.5")	D 278mm (10.9")	1 2 3 4
W 300mm (11.8")	D 450mm (17.7")	H 304mm (12")	W 215mm (8.5")	D 428mm (16.9")	1 2 3 4
W 300mm (11.8")	D 600mm (23.6")	H 304mm (12")	W 215mm (8.5")	D 578mm (22.8")	1 2 3 4
W 380mm (15")	D 380mm (15")	H 304mm (12")	W 295mm (11.6")	D 358mm (14.1")	1 2 3
W 380mm (15")	D 510mm (20")	H 304mm (12")	W 295mm (11.6")	D 488mm (19.2")	1 2 3
W 380mm (15")	D 600mm (23.6")	H 304mm (12")	W 295mm (11.6")	D 578mm (22.8")	1 2 3
W 450mm (17.7")	D 450mm (17.7")	H 304mm (12")	W 365mm (14.4")	D 428mm (16.9")	1 2
W 450mm (17.7")	D 510mm (20")	H 304mm (12")	W 365mm (14.4")	D 488mm (19.2")	1 2
W 450mm (17.7")	D 600mm (23.6")	H 304mm (12")	W 365mm (14.4")	D 578mm (22.8")	1 2
W 600mm (23.6")	D 450mm (17.7")	H 304mm (12")	W 515mm (20.3")	D 428mm (16.9")	1 2

This locker includes shelf positions so internal shelves can be added as optional extras.

6 doors



External		Internal dimensions per locker compartment			Nests available
W 225mm (9")	D 450mm (17.7")	H 248mm (9.8")	W 140mm (5.5")	D 428mm (16.9")	1 2
W 300mm (11.8")	D 300mm (11.8")	H 248mm (9.8")	W 215mm (8.5")	D 278mm (10.9")	1 2 3 4
W 300mm (11.8")	D 380mm (15")	H 248mm (9.8")	W 215mm (8.5")	D 358mm (14.1")	1 2 3 4
W 300mm (11.8")	D 450mm (17.7")	H 248mm (9.8")	W 215mm (8.5")	D 428mm (16.9")	1 2 3 4
W 300mm (11.8")	D 600mm (23.6")	H 248mm (9.8")	W 215mm (8.5")	D 578mm (22.8")	1 2 3 4
W 380mm (15")	D 380mm (15")	H 248mm (9.8")	W 295mm (11.6")	D 358mm (14.1")	1 2 3
W 380mm (15")	D 510mm (20")	H 248mm (9.8")	W 295mm (11.6")	D 488mm (19.2")	1 2 3
W 380mm (15")	D 600mm (23.6")	H 248mm (9.8")	W 295mm (11.6")	D 578mm (22.8")	1 2 3
W 450mm (17.7")	D 450mm (17.7")	H 248mm (9.8")	W 365mm (14.4")	D 428mm (16.9")	1 2
W 450mm (17.7")	D 510mm (20")	H 248mm (9.8")	W 365mm (14.4")	D 488mm (19.2")	1 2
W 450mm (17.7")	D 600mm (23.6")	H 248mm (9.8")	W 365mm (14.4")	D 578mm (22.8")	1 2
W 600mm (23.6")	D 450mm (17.7")	H 248mm (9.8")	W 515mm (20.3")	D 428mm (16.9")	1 2

 All lockers are fitted with **AB locks** as standard. Take a look at alternative locking options here.

EVERYDAY LOCKERS RANGE OVERVIEW

Lower height lockers

1 door

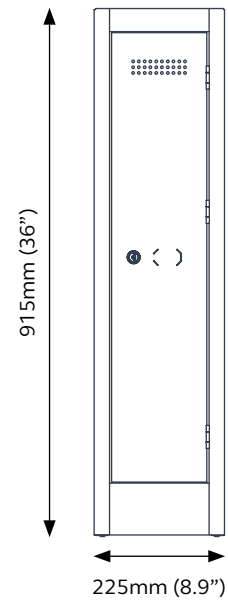

External			Internal (Below shelf)	Internal (Above shelf)	Internal dimensions per locker compartment		Nests available
H 915mm (36")	W 225mm (8.9")	D 380mm (15")	H 507mm (20")	H 246mm (9.7")	W 140mm (5.5")	D 358mm (14.1")	1 2 3 4
H 1330mm (52.4")	W 500mm (19.7")	D 450mm (17.7")	H 885mm (34.8")	H 283mm (11.1")	W 415mm (16.3")	D 428mm (16.9")	1 2
H 1370mm (53.9")	W 300mm (11.8")	D 300mm (11.8")	H 911mm (35.9")	H 297mm (11.7")	W 215mm (8.5")	D 278mm (11")	1 2 3 4
H 1370mm (53.9")	W 300mm (11.8")	D 450mm (17.7")	H 911mm (35.9")	H 297mm (11.7")	W 215mm (8.5")	D 428mm (16.9")	1 2 3 4
H 1750mm (68.9")	W 500mm (19.7")	D 450mm (17.7")	H 1199mm (47.2")	H 390mm (15.4")	W 415mm (16.3")	D 428mm (16.9")	1 2

This locker includes 1 internal shelf and 1 coat hook.

2 doors

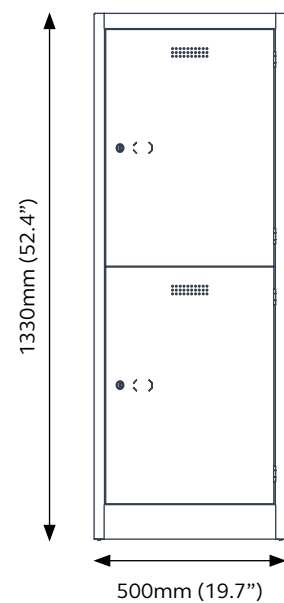

External			Internal dimensions per locker compartment			Nests available
H 1330mm (52.4")	W 500mm (19.7")	D 450mm (17.7")	H 570mm (22.4")	W 415mm (16.3")	D 428mm (16.9")	1 2
H 1370mm (53.9")	W 300mm (11.8")	D 300mm (11.8")	H 590mm (23.2")	W 215mm (8.5")	D 278mm (10.9")	1 2 3 4
H 1370mm (53.9")	W 300mm (11.8")	D 450mm (17.7")	H 590mm (23.2")	W 215mm (8.5")	D 428mm (16.9")	1 2 3 4
H 1750mm (68.9")	W 500mm (19.7")	D 450mm (17.7")	H 780mm (30.7")	W 415mm (16.3")	D 428mm (16.9")	1 2

This locker includes shelf positions so internal shelves can be added as optional extras.





All lockers are fitted with **AB locks** as standard. Take a look at alternative locking options here.

EVERYDAY LOCKERS RANGE OVERVIEW

Lower height lockers

3 doors

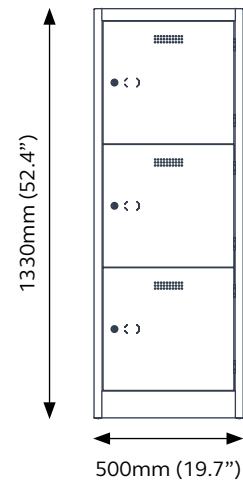

External	Internal dimensions per locker compartment	Nests available
H 1330mm (52.4") W 500mm (19.7") D 450mm (17.7")	H 370mm (14.6") W 415mm (16.3") D 428mm (16.9")	1 2
H 1370mm (53.9") W 300mm (11.8") D 300mm (11.8")	H 383mm (15.1") W 215mm (8.5") D 278mm (11")	1 2 3 4
H 1370mm (53.9") W 300mm (11.8") D 450mm (17.7")	H 383mm (15.1") W 215mm (8.5") D 428mm (16.9")	1 2 3 4
H 1750mm (68.9") W 500mm (19.7") D 450mm (17.7")	H 510mm (20.1") W 415mm (16.3") D 428mm (16.9")	1 2

This locker includes shelf positions so internal shelves can be added as optional extras.

4 doors

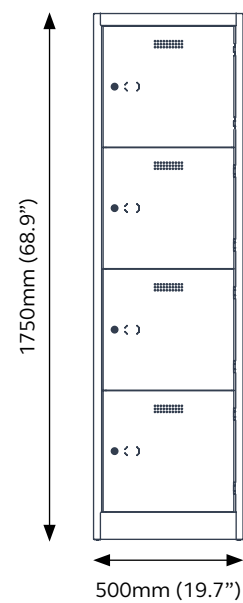

External	Internal dimensions per locker compartment	Nests available
H 1750mm (68.9") W 500mm (19.7") D 450mm (17.7")	H 375mm (14.8") W 415mm (16.3") D 428mm (16.9")	1 2

This locker includes shelf positions so internal shelves can be added as optional extras.



All lockers are fitted with **AB locks** as standard. Take a look at alternative locking options here.

EVERYDAY LOCKERS RANGE OVERVIEW

Lower height lockers

5 doors

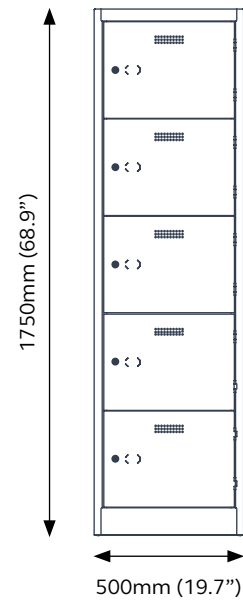

External			Internal dimensions per locker compartment			Nests available
H 1750mm (68.9")	W 500mm (19.7")	D 450mm (17.7")	H 294mm (11.6")	W 415mm (16.3")	D 428mm (16.9")	1 2

This locker includes shelf positions so internal shelves can be added as optional extras.

6 doors

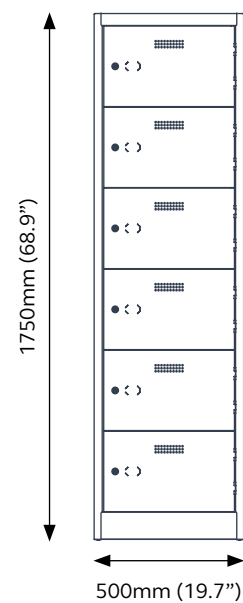

External			Internal dimensions per locker compartment			Nests available
H 1750mm (68.9")	W 500mm (19.7")	D 450mm (17.7")	H 240mm (9.4")	W 415mm (16.3")	D 428mm (16.9")	1 2

Line drawings are for illustrative purposes only.

WORKWEAR LOCKERS

Designed to fit around you

There are five types of Workwear Lockers to choose from. Each has been designed to not only withstand the wear and tear of daily use, but provide organised, secure storage with specific workwear needs in mind, such as compartments to fit police helmets, internal shelves and dividers, and lockers suited to multiple users.

As with all Primary Lockers, the carcase is light grey as standard, but there are a choice of door colours with the option to upgrade to anti-microbial paint.* Alternatively, if the lockers will be placed in areas susceptible to rusting or you require an extra level of protection, Workwear Lockers can be specified in galvanized steel, with the same paint finishes available.* You can also specify sloping tops, steel locker stands, raised feet, and add benching if required.

Rest assured that our Workwear Lockers are a secure option for workwear and personal belongings. They come with a key lock as standard but there are several lock options to choose from to suit your specific needs.



- Each of our Workwear Lockers have varying internal storage solutions
- Ventilated doors allow air to flow through the lockers
- Discreet label holders on all doors
- Strong hinges withstand rough handling
- Add optional sloping tops, steel lockers stands or raised feet with leveling capabilities
- Choose from a selection of popular industry paints available for door fronts, or specify Biocote paint finishes to inhibit bacteria growth by 99.99%*
- Lockers can be specified in galvanized steel for added protection against corrosion and damage*
- Choose from a selection of locks to suit different industry needs

* Surcharges apply.



WORKWEAR LOCKERS RANGE OVERVIEW

Primary Lockers - Range overview



All lockers are fitted with **AB locks** as standard. Take a look at alternative locking options here.

Police Lockers - 1 door

Clean and Dirty Lockers - 1 door

Combi Lockers - 1 door

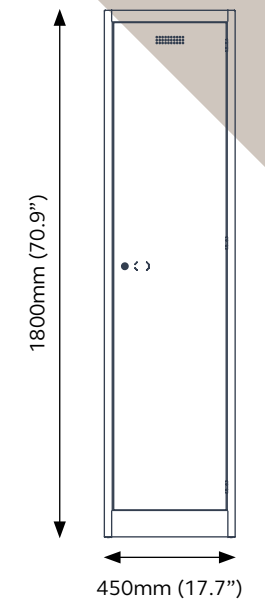
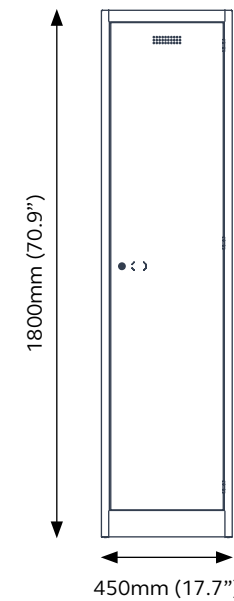
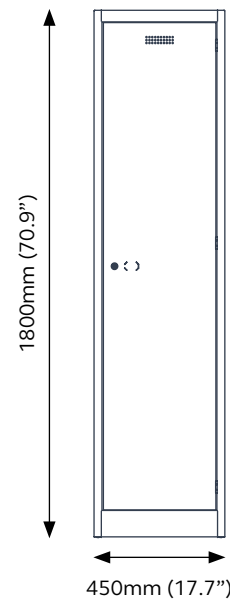

Manufactured in line with industry standards, the single door Police Locker comprises of two large compartments, a top shelf designed to store Police headwear, and hanging space below with a coat rail for uniform.

The Clean and Dirty Locker is a single door locker divided into two clothing compartments with hanging rails, perfect for separating clean clothes from dirty workwear and overalls. With shelving above, there is also space for your personal belongings to be kept clean, safe and secure.

The Combi Locker features a narrow hanging space with a coat hook and a series of internal shelves above and to the side, enclosed behind a single door. There is enough space to store personal and workwear items in a range of working environments.

External	Internal (Below shelf)	Internal (Above shelf)	Internal dimensions per locker compartment	
H 1800mm (70.9")	H 1319mm (51.9")	H 318mm (12.5")	W 365mm (14.4")	D 578mm (22.8")
W 450mm (17.7")				
D 600mm (23.6")				

External	Internal (Below shelf)	Internal (Above shelf)	Internal dimensions per locker compartment	
H 1800mm (70.9")	H 1319mm (51.9")	H 318mm (12.5")	W 365mm (14.4")	D 578mm (22.8")
W 450mm (17.7")				
D 600mm (23.6")				

External	Internal (Below shelf)	Internal (Above shelf)	Internal dimensions per locker compartment	
H 1800mm (70.9")	H 1319mm (51.9")	H 318mm (12.5")	W 365mm (14.4")	D 428mm (16.9")
W 450mm (17.7")				
D 450mm (17.7")				

WORKWEAR LOCKERS RANGE OVERVIEW



All lockers are fitted with **AB locks** as standard. Take a look at alternative locking options here.

Two Person Lockers - 2 doors



The Two Person Locker has two secure doors that are private to the user, with hanging space and coat hooks inside. There are also two individual lockers for each of the users to access, stacked on top of the unit. An ideal storage solution when space is limited, whilst still providing employees with a safe, secure place to stow their belongings.

Twin Lockers - 2 doors



Tall and sturdy, the Twin Locker provides ample hanging space to stow longer items of clothing. With two individual doors, this unit is suitable for two users. Behind each door, a hanging space with a coat rail is provided, plus a shelf above to stow personal belongings.

External	Internal (Lower locker)	Internal (Upper locker)
H 1800mm (70.9")	H 1233mm (48.5")	H 190mm (7.5")
W 450mm (17.7")	W 155mm (6.1")	W 366mm (14.4")
D 450mm (17.7")	D 428mm (16.9")	D 428mm (16.9")

External	Internal (Below shelf)	Internal (Above shelf)	Internal dimensions per locker compartment	
H 1800mm (70.9")	H 1319mm (51.9")	H 318mm (12.5")	W 366mm (14.4")	D 578mm (22.8")
W 450mm (17.7")				
D 600mm (23.6")				

GALVANIZED STEEL

Primary Lockers have been designed to be incredibly hard wearing and able to withstand daily handling in high traffic environments. However, if your workplace requires an extra level of protection, or the lockers will be placed in areas susceptible to rusting, specifying your lockers in galvanized steel will give you extra peace of mind.

Galvanized steel provides an added thin layer of protection over the entire steel surface, protecting against corrosion and damage.

- The entire locker is manufactured from galvanized steel giving total protection.
- Superior protection against rust, abrasion and water.
- Recommended for wet and humid environments such as swimming pools and gyms.
- Galvanized steel is longer lasting and requires less maintenance, meaning it is a more sustainable option.



Get in touch to find out more about specifying Primary Lockers in galvanized steel.



View all Primary Lockers finishes.



DOWNLOAD IMAGES



LOCKER STANDS AND BENCHES

Locker stands

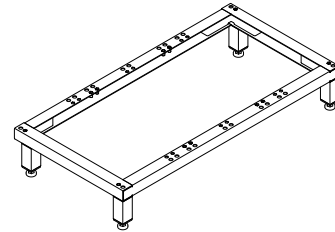

Locker stand

H 150mm	W 450mm
H 150mm	W 600mm
H 150mm	W 760mm
H 150mm	W 900mm
H 150mm	W 1000mm
H 150mm	W 1140mm
H 150mm	W 1200mm

Suits all locker depths

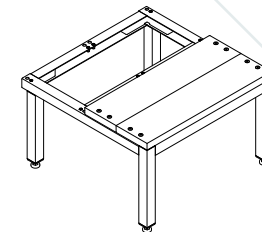

Locker stand with bench seat

H 350mm	W 450mm
H 350mm	W 600mm
H 350mm	W 760mm
H 350mm	W 900mm
H 350mm	W 1000mm
H 350mm	W 1140mm
H 350mm	W 1200mm

Suits all locker depths

Standalone benches

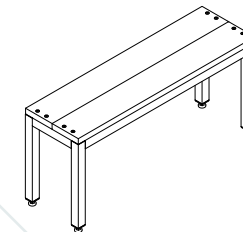

H 470mm	W 1000mm	D 300mm
H 470mm	W 1200mm	D 300mm
H 470mm	W 1500mm	D 300mm

- M6 fixing bolts are provided with locker stands and benches.
- The steel frames match the light grey locker carcasses and are also available in galvanized steel.**
- Bench slats are made from recycled plastic and are available in black as standard.

**Surcharges apply.

Cloakroom benches

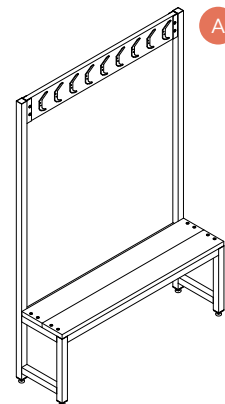

A Single-sided cloakroom benches

H 1800mm	W 1200mm	D 300mm	470mm seat height	9 hooks
H 1800mm	W 1500mm	D 300mm	470mm seat height	12 hooks

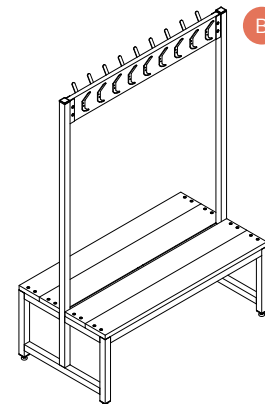

B Double-sided cloakroom benches

H 1800mm	W 1200mm	D 300mm*	470mm seat height	18 hooks (9 p/s)
H 1800mm	W 1500mm	D 300mm*	470mm seat height	24 hooks (12 p/s)

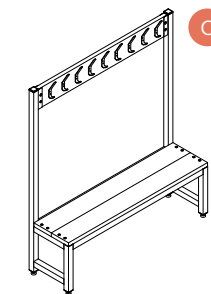

C Junior height single-sided cloakroom benches

H 1370mm	W 1200mm	D 300mm	400mm seat height	9 hooks
H 1370mm	W 1500mm	D 300mm	400mm seat height	12 hooks

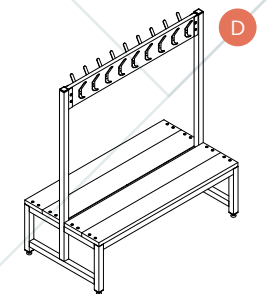

D Junior height double-sided cloakroom benches

H 1370mm	W 1200mm	D 300mm*	400mm seat height	18 hooks (9 p/s)
H 1370mm	W 1500mm	D 300mm*	400mm seat height	24 hooks (12 p/s)

*Individual seat depth 300mm, overall depth 600mm.



Locker sloping tops

W 450mm D 380mm
W 450mm D 450mm
W 450mm D 600mm

W 600mm D 300mm
W 600mm D 380mm
W 600mm D 450mm
W 600mm D 600mm

W 675mm D 380mm

W 760mm D 380mm
W 760mm D 510mm

W 900mm D 300mm
W 900mm D 380mm
W 900mm D 450mm
W 900mm D 510mm
W 900mm D 600mm

W 1000mm D 450mm

W 1140mm D 380mm
W 1140mm D 510mm
W 1140mm D 600mm

W 1200mm D 300mm
W 1200mm D 380mm
W 1200mm D 450mm
W 1200mm D 600mm

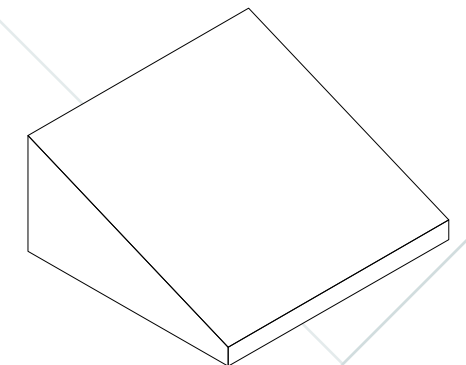
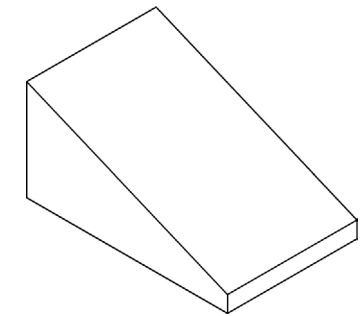

All sloping tops are 150mm high.

- The sloping tops match the light grey locker carcasses and are also available in Galvanized steel.*
- Adhesive strips are provided for fitting the sloping top.

*Other finishes are available with a surcharge.

LOCKS

We design and manufacture the highest quality personal storage and workwear lockers, but we also have the knowledge and expertise on hand to advise you on the best lock choice.

Our selection of locking options available for Primary Lockers give all employees – whether permanent, mobile or nomadic – a sense of peace of mind and belonging whilst in the workplace.

The lockers are fitted with AB locks as standard but you can choose to upgrade to latch, coin return, combination or mechanical combination locks, which are all great solutions for both permanent employees and visitors.



Speak to us about your locking requirements and we can recommend a solution to best suit your needs.

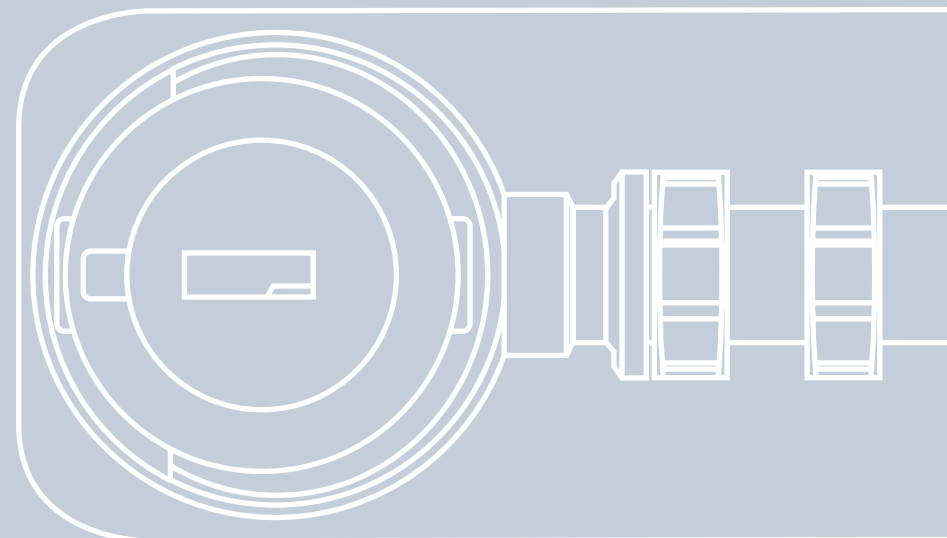

AB Lock

AB locks are a great, cost effective option if you are looking for a straightforward and secure lock solution with user keys, ideal for both assigned and shared lockers.



Latch Lock

Latch locks are recommended for Primary Lockers because they have a robust lock body that is ideal for high traffic and shared locker areas. They are a low-cost lock choice without the worry of master or replacement keys. Please note padlocks are not supplied.



Coin Return Lock

Ideal for public locker spaces such as changing rooms, coin return locks are a keyless option for the user and operate with a range of coins or tokens. They are controlled using a master key, making the lock safe and convenient for both users and management. Choose from coin return or coin retain to suit your needs.

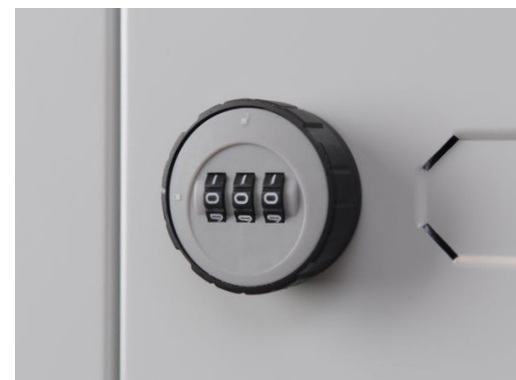

Combination Lock

Robust, compact and simple to use, the combination lock is a low-cost solution, recommended for both personal and shared lockers. There are up to 1000 three-digit codes that can be set on the lock for user peace of mind.

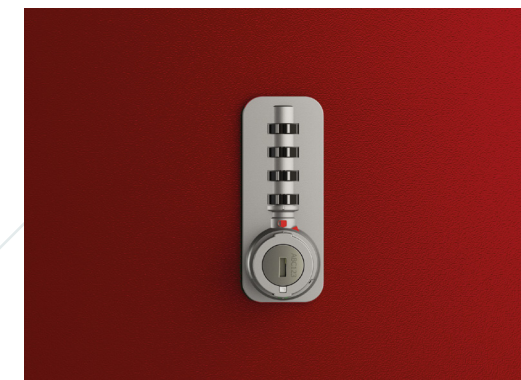

M3 Mechanical Combination Lock (Assigned use)

The M3 Mechanical Lock is ideal for a single user, with secure four-digit codes, integrated scramble feature, and a master key for management override.

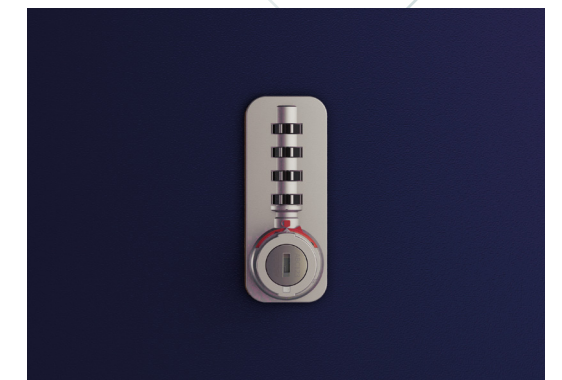

M2 Mechanical Combination Lock (Shared use)

All the benefits of the M3 Mechanical Combination Lock, but more suited to public use with new user codes easily set up each time the lock is open.

FINISHING TOUCHES

Primary Lockers create smart, reliable personal storage for a variety of workplaces, education settings, and leisure requirements.

There is a choice of standard paints or you can choose anti-microbial Biocote finishes which inhibit the growth of bacteria by 99.99%.

Alternatively, Primary Lockers can be specified in galvanized steel for an extra level of protection against damage and corrosion, for peace of mind particularly when the lockers are placed in wet or humid environments.*

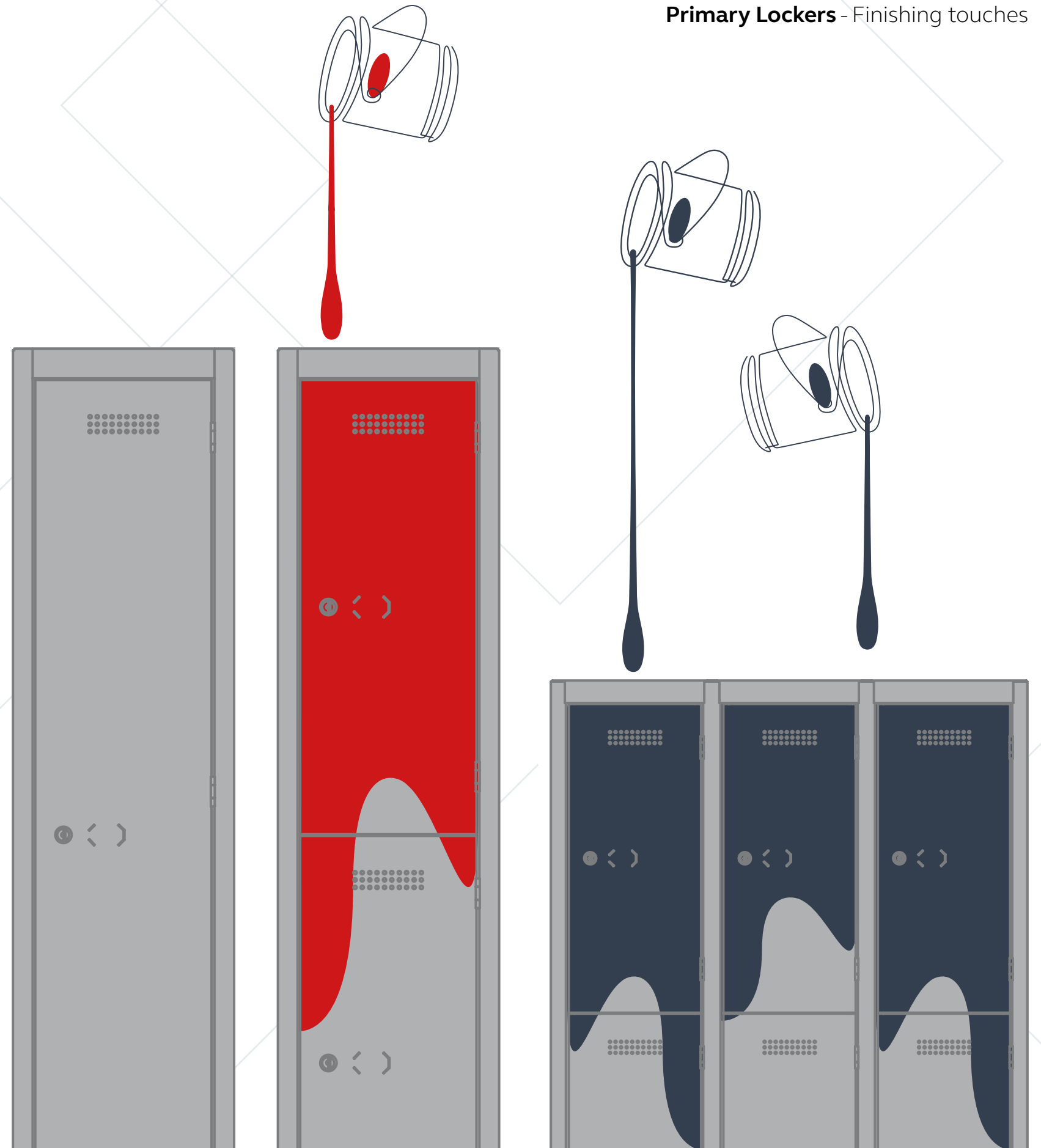

* Surcharges apply for Biocote paint and galvanized steel upgrades.

PAINT FINISHES

Primary Lockers - Finishing touches

Classic steel palette*



Oxford Blue (AY7) doors
Light Grey (AV7) carcase



Cardinal Red (AY8) doors
Light Grey (AV7) carcase

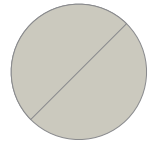

Light Grey (AV7) doors
Light Grey (AV7) carcase



Black recycled plastic
Light Grey (AV7)

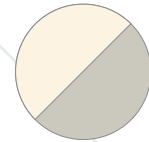

Chalk (AB9) doors
Light Grey (AV7) carcase



Beige (AV8) doors
Light Grey (AV7) carcase

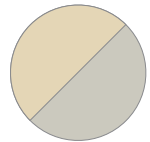

Cream (AV6) doors
Light Grey (AV7) carcase



Coffee (AV5) doors
Light Grey (AV7) carcase



Black (AV1) doors
Light Grey (AV7) carcase



Anthracite Grey (AA3) doors
Light Grey (AV7) carcase



Slate (AN9) doors
Light Grey (AV7) carcase



Silver (ARN) doors
Light Grey (AV7) carcase



Goose Grey (AV4) doors
Light Grey (AV7) carcase

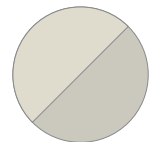

Portland (AB8) doors
Light Grey (AV7) carcase



Traffic White (BA5) doors
Light Grey (AV7) carcase

Other steel paint finishes are available with a surcharge.
Please speak to your Bisley Representative.

Biocote finish*

For improved hygiene, especially with concerns around shared locker use, Primary Lockers can be specified in Biocote which is an anti-microbial paint that works actively against microbes, diminishing the growth of bacteria by up to 99.99%.

Galvanized steel*

For extra protection against corrosion, rusting and rough handling, Primary Lockers are available in galvanized steel. Not only does this mean the lockers will be longer lasting and need less maintenance, but they will also be suitable in humid environments, such as swimming pool changing rooms. Please note, a paint finish will still need to be specified for this option.



Get in touch to find out more about galvanized steel and Biocote paint options.

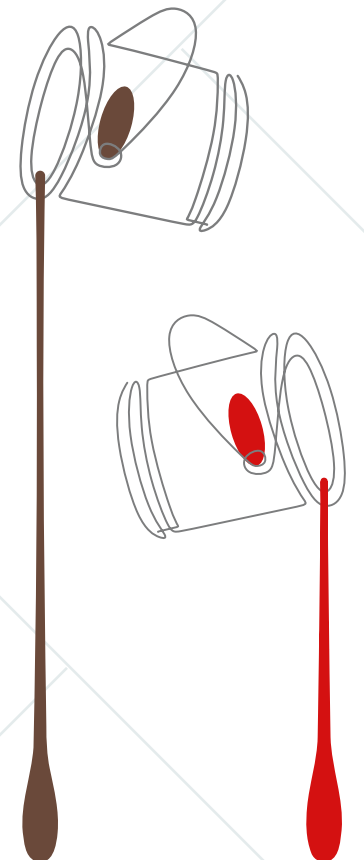

OUR COMMITMENT

Better for you, better for the environment

As a proud British manufacturer, we take our responsibilities towards the environment very seriously, ensuring that sustainability runs through everything we do. Our dedicated Sustainability team ensures that our facilities are as sustainable as possible, while making sure that our products last and are sustainably sourced.

Bisley products are designed for functionality, durability, and a long service life. They are all tested rigorously to British and European harmonised standards for safety, strength and stability. We have also invested in the undertaking of Life Cycle Analyses (LCA) for much of our steel product portfolio, to fully understand their environmental impacts in terms of global warming, acidification, eutrophication, ozone depletion and other indicators across all phases of a product's life cycle - from cradle-to-grave.

As for energy, we source all of the energy that powers our manufacturing activities through renewable energy tariff and we also participate in the Energy Savings Opportunity Scheme (ESOS), which has led to substantial investment in procurement and installation of energy efficient machinery and equipment.

But, we can always do more, and the team is constantly reviewing how we do things and how we might improve.

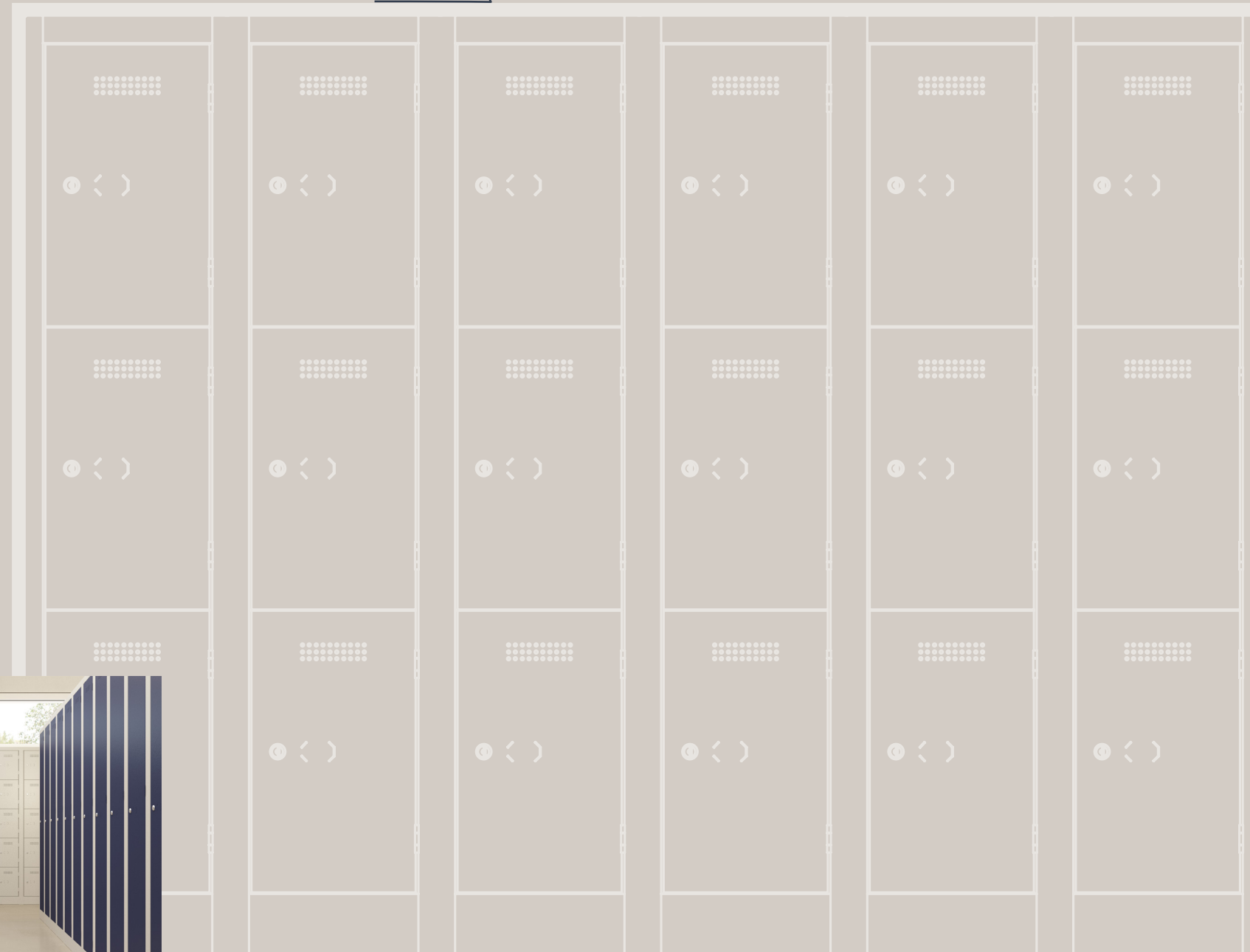

Visit [bisley.com](https://www.bisley.com) to find out more, or contact your Bisley Representative for more information on Primary Lockers.

Get in touch

www.bisley.com/get-in-touch



HEAD OFFICE

Caswell Way
Reevesland Ind Est
Newport
South Wales
NP19 4PW

TELEPHONE:
+44 (0)1633 637 383



LONDON SHOWROOM

32 Dallington Street
London
EC1V 0BB

TELEPHONE:
+44 (0)203 952 4000



NORTH AMERICA

1140 Broadway
Suite 902
New York
New York
10001

TELEPHONE:
1-212-675-3055



DUBAI

Office 4501
U-Bora Tower
Marasi Drive
Business Bay
Dubai
United Arab Emirates

TELEPHONE:
00971 (4) 450 3747



FRANCE

Immeuble le Corosa
1-3 rue Eugène
et Armand Peugeot
92500 Rueil Malmaison

TELEPHONE:
+33 (0)1 41 39 97 20



GERMANY

Hauptsitz und Showroom
Wiesenstraße 70 A3
40549 Düsseldorf

TELEPHONE:
+49 (0)211 87541 600



IRELAND

Bisley House
IDA Bray Business Park
Southern Cross Road
Bray
Co. Wicklow
Ireland

TELEPHONE:
00353 1 2769100



NETHERLANDS

Burg. Stekelenburgplein 199
Unit 2.4
5041 SC
Tilburg

TELEPHONE:
+31 (0)13 590 10 03

